

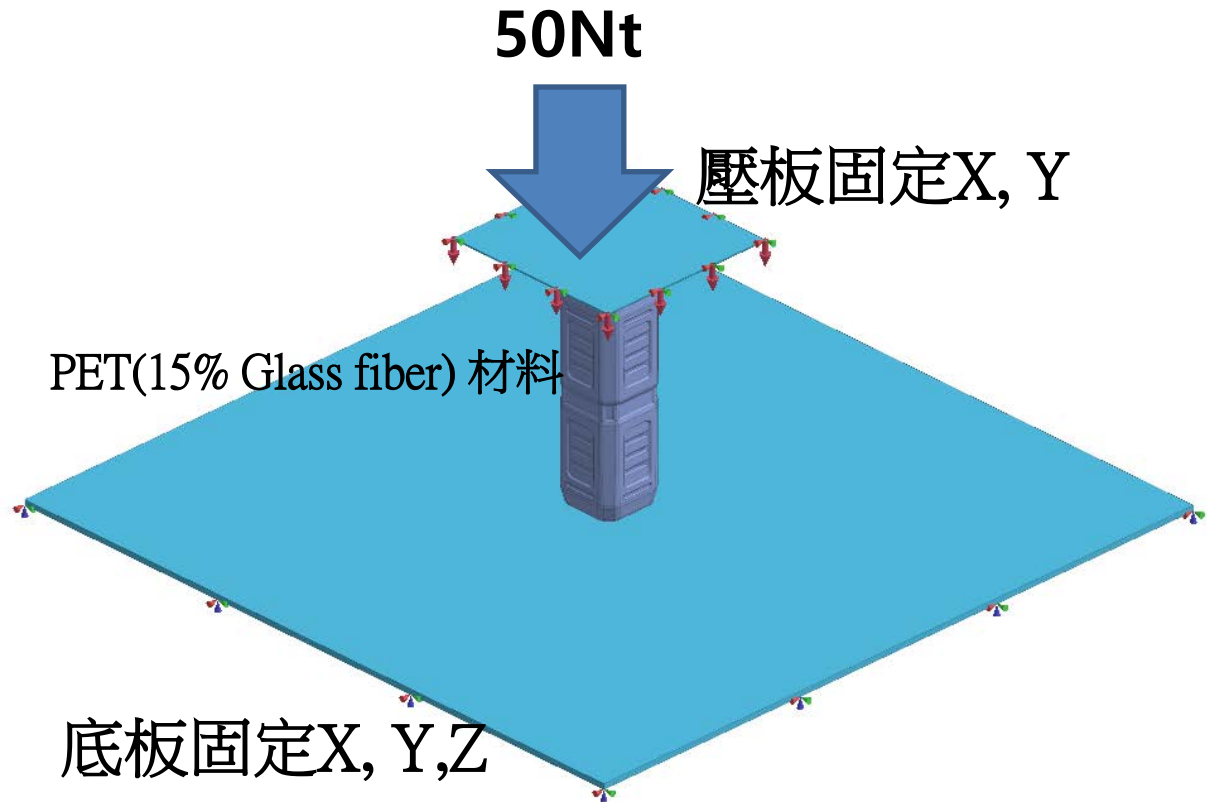

寶特瓶_下壓線性分析

Simple, but Everything.







Step1.匯入3D 模型

MeshFree支援各類CAD 格式

- Parasolid (9 - 29) Files (*.x_t;*.xmt_txt;*.x_b;*.xmt_bin)
- ACIS (R1 - 2017 1.0) Files (*.sat;*.sab;*.asat;*.asab)
- STEP (AP203, AP214, AP242) Files (*.stp;*.step)
- IGES (Up to 5.3) Files (*.igs;*.iges)
- Pro-E (16 - Creo 3.0) Files (*.prt;*.prt.*;*.asm;*.asm.*)
- CATIA V4 (CATIA 4.1.9 - 4.2.4) Files (*.model;*.exp;*.session)
- CATIA V5 (V5R8 - V5-6R2016) Files (*.CATPart;*.CATProduct)
- Solid Works (98 - 2017) Files (*.sldprt;*.sldasm)
- Unigraphics (11 - NX11) Files (*.prt)
- Inventor Part (V6 - V2017) Files (*.ipt)
- Inventor Assembly (V11 - V2017) Files (*.iam)
- Solid Edge (V18 - ST9) Files (*.par;*.asm;*.psm)

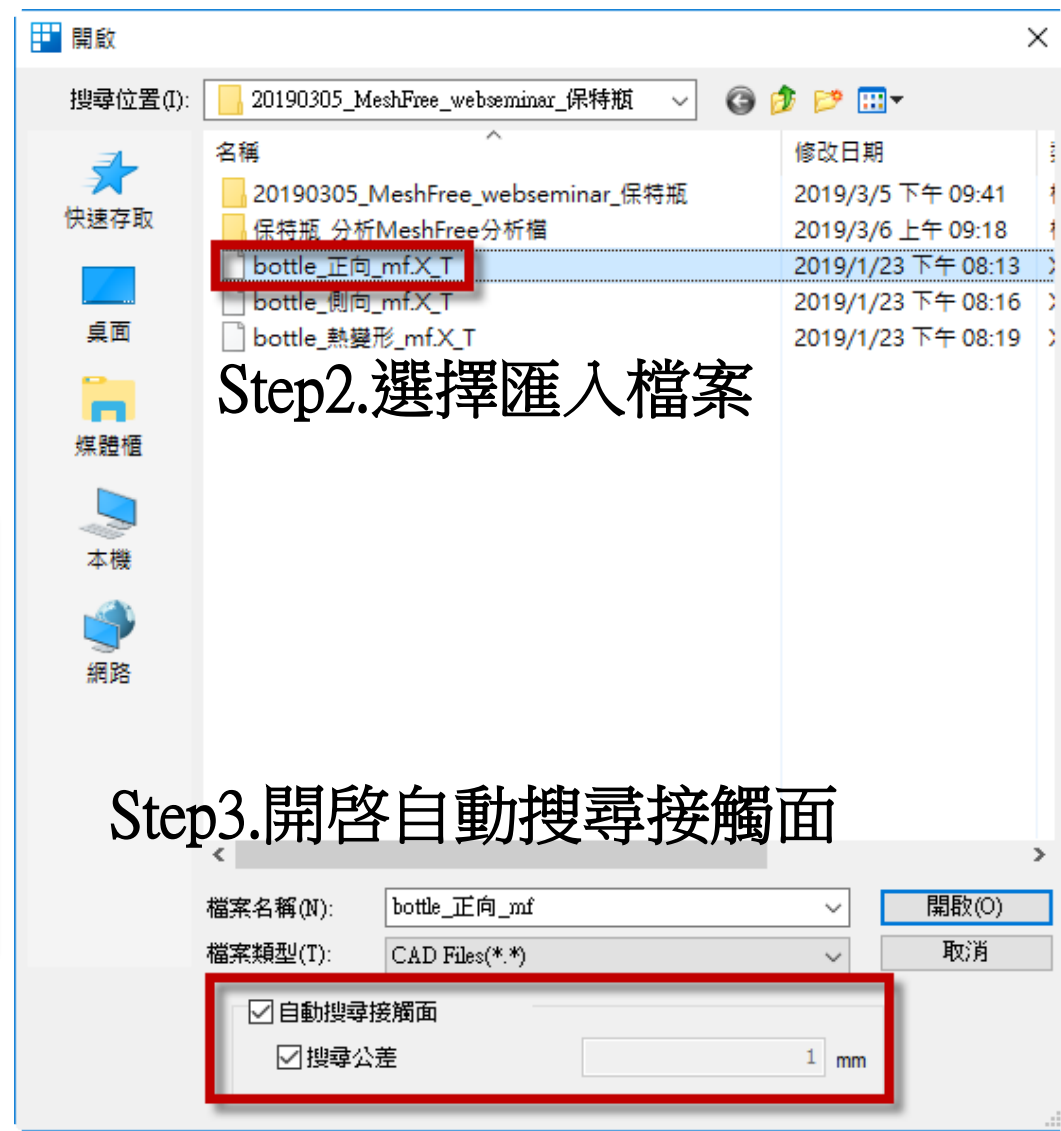

Step2.選擇匯入檔案

Step3.開啓自動搜尋接觸面

新增PET(15% Glass fiber) 材料

材料定義

名稱: PET (15 Glass fiber) 顏色: 

分類: Plastics

- ABS
- ABS PC
- ABS-GF
- Acrylic
- Acrylic (Medium-high impact)
- EPDM
- Epoxy
- Gypsum bonded particleboard, par
- Gypsum bonded particleboard, per
- MGR
- Nylon
- Nylon 6/10
- PA Type 6
- PBT General Purpose
- PC
- PC High Viscosity
- PCB
- P-Cu
- PDMS (Polydimethylsiloxane)
- PE High Density
- PE Low/Medium Density
- PET (15% Glass fiber)**
- PET (33% Glass fiber)
- PET (unfilled, amorphous)
- PMMA
- Polycarbonate
- Polycarbonate-GF
- Polyethylene

載入 編輯

線性 彈塑性

結構

彈性模量	5710	N/mm ²
泊松比	0.3735	
質量密度	1.33e-006	kg/mm ³
屈服應力	0	N/mm ²

熱膨脹

熱膨脹係數	3.1e-005	
參考溫度	0	[°C]

熱

熱傳導係數	0.00038	W/(mm·[°C])
比熱	1460	J/(kg·[°C])
發熱係數	1	



滑鼠右鍵,材料定義



模型樹顯示指定材料

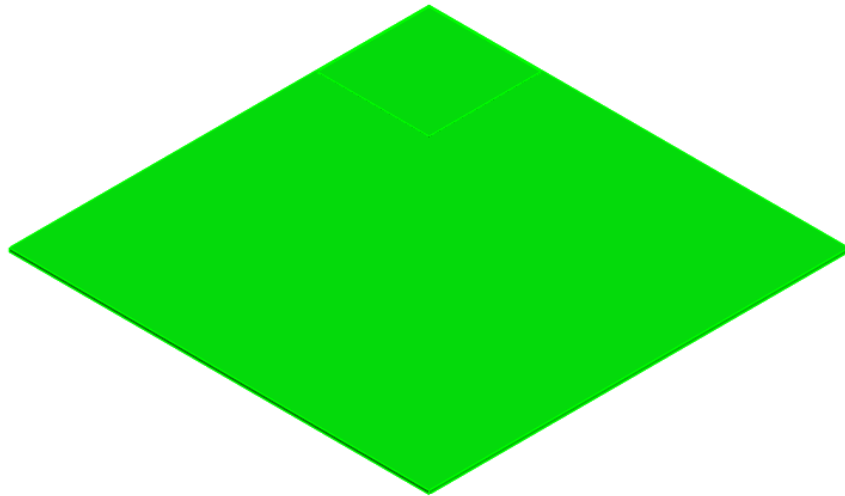
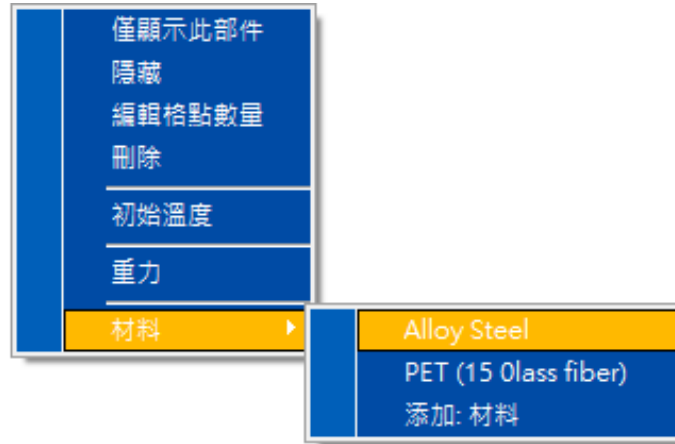

滑鼠右鍵,材料定義



模型樹顯示指定材料

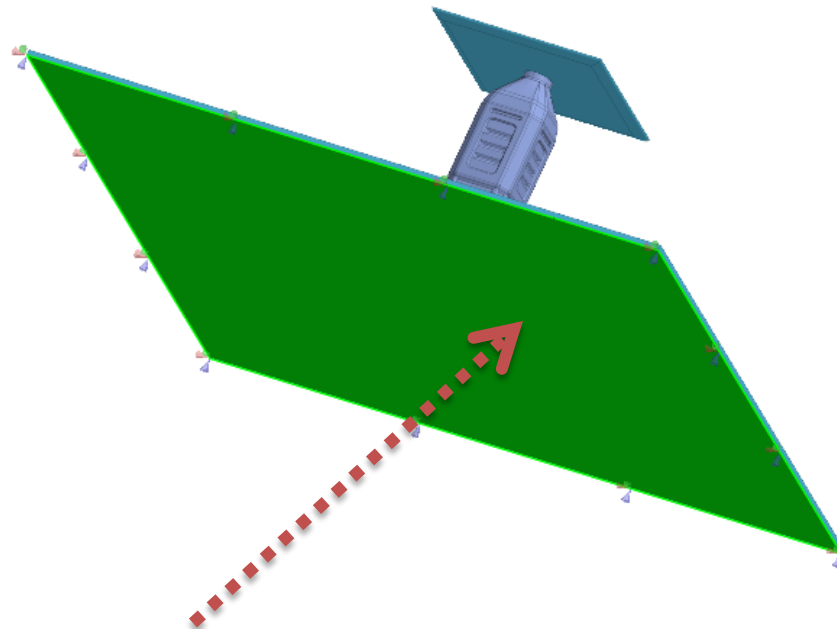
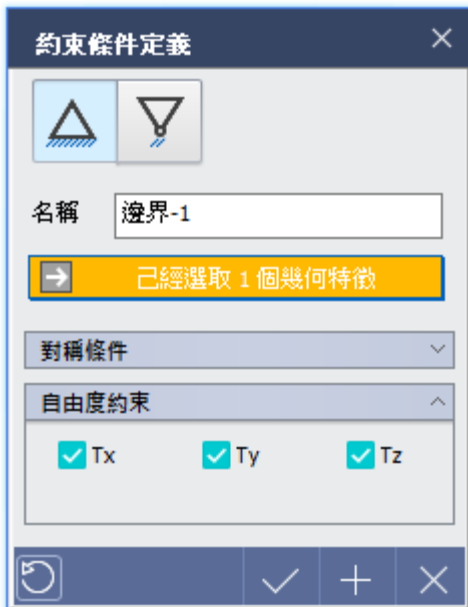

選取底板特徵
拘束(TX/TY/TZ)

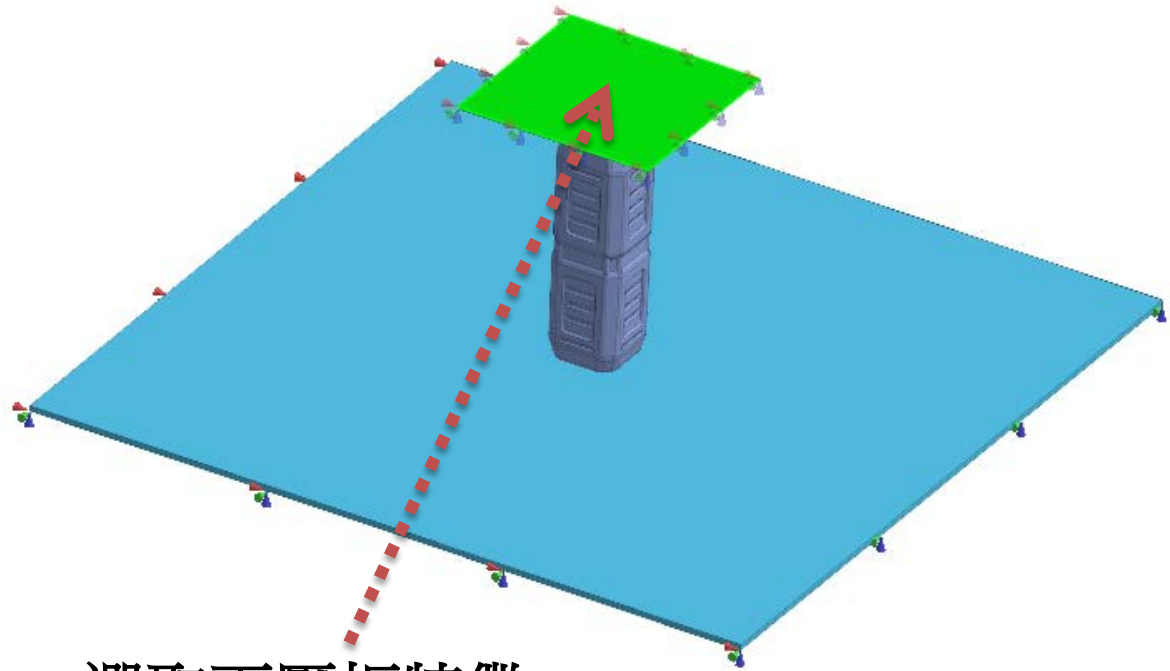

選取下壓板特徵
拘束(TX/TY)

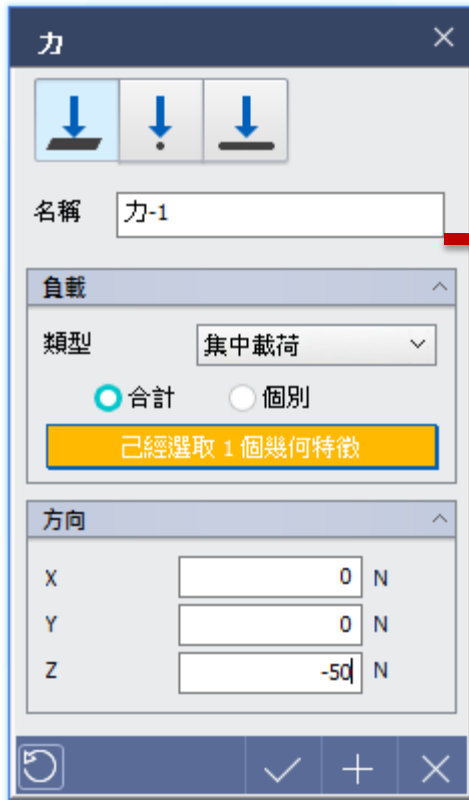

選擇下壓板特徵

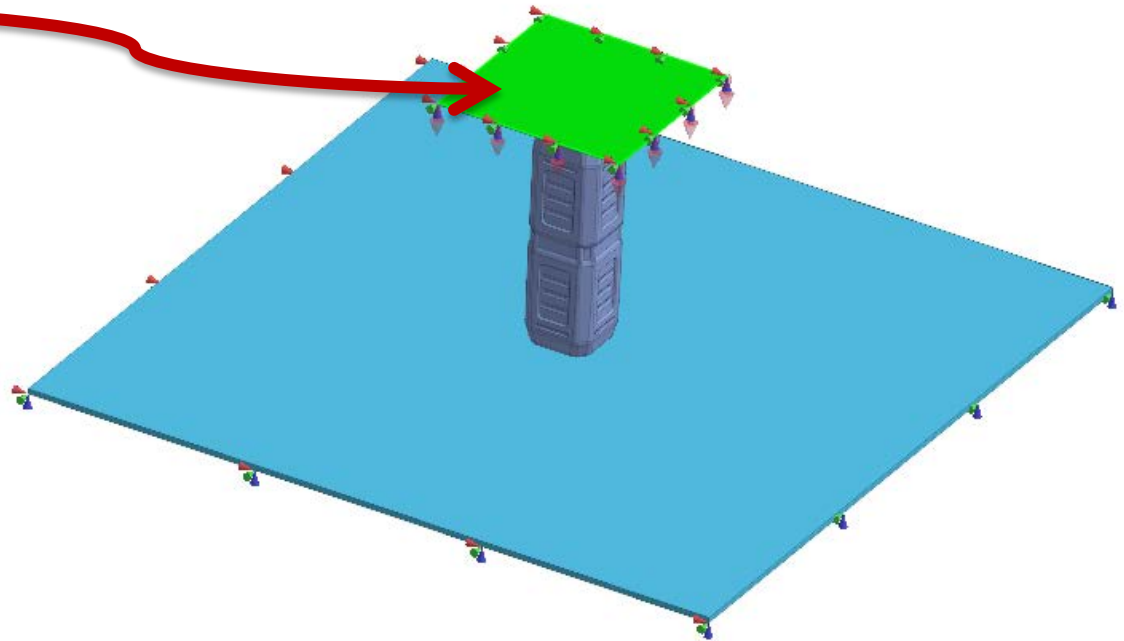

下壓50Nt

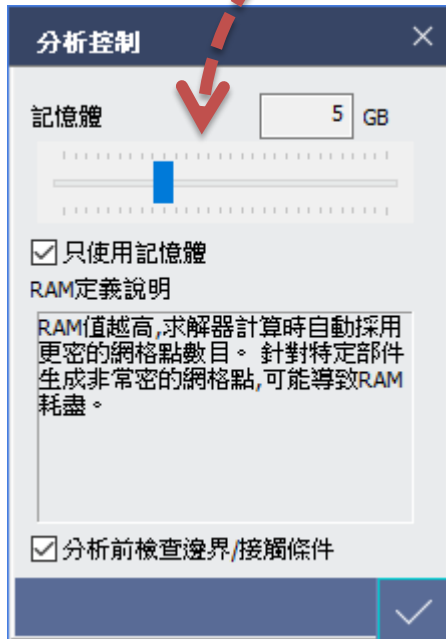
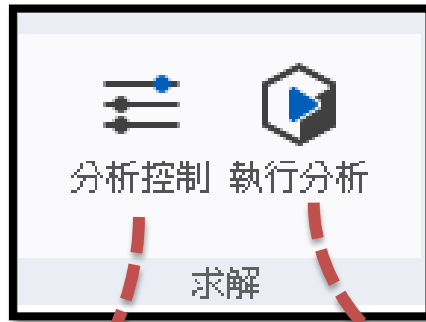

記憶體大小

- 1.計算速度
- 2.分析準確性

midas MeshFree - MESHFREE_保特視_下壓線性分析

操作選項 工具

開始 分析條件 約束條件 剛性連接 彈簧 重力 力 集中質量 壓力 扭矩 離心力 位移 初始溫度 結構溫度 分析控制 執行分析 分析結果

模型 材料 顏色

模型設置

- 幾何(G)
 - 拉伸 Alloy Steel
 - 拉伸(I) Alloy Steel
 - GDXL-HCT-580_PET (15 Glass fiber)
- 材料
 - Alloy Steel
 - PET (15 Glass fiber)
- 接觸(C)
 - GDXL-HCT-580_焊接
 - 拉伸-GDXL-HC..._焊接
- 邊界(B)
 - 邊界-1 約束條件
 - 邊界-2 約束條件
- 載荷(L)
 - 力-1 力

分析

- 分析狀況
 - 線性分析-1

求解程序 [1/1]

- 自動網點計算
- 網點創建
- 接觸搜索
- 設置
- 系統矩陣計算
- 求解
- 分析結果

14%

取消

MEMORY ESTIMATION TRIAL = 2. TOTAL DOF = 1092144
MEMORY ESTIMATION TRIAL = 3. TOTAL DOF = 577179

153.5860, 361.0231, 411.3659

分析類型 線性分析-1
結果 DISPLACEMENT-XYZ



0.0 33.3 66.7

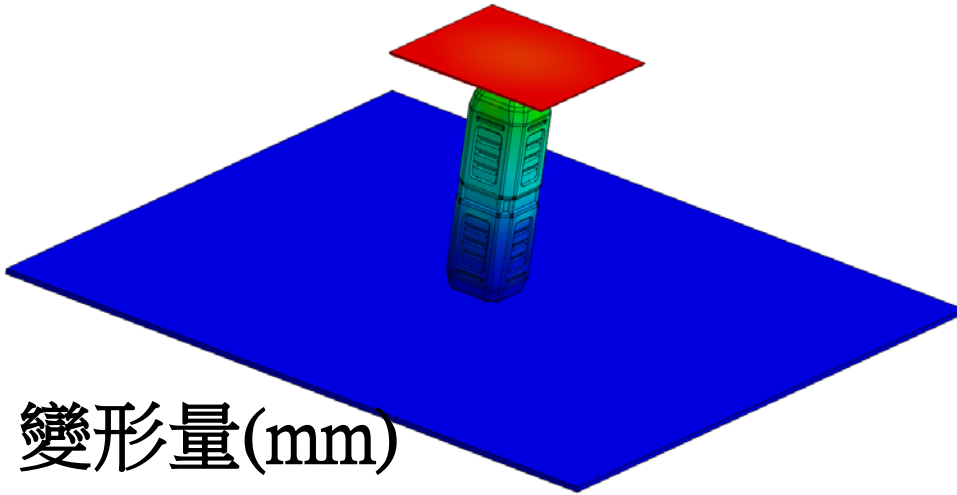

變形量(mm)

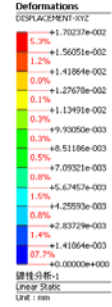

分析類型 線性分析-1
結果 STRESS VON MISES



0.0 33.3 66.7



應力(MPa)

